

## OPERATING INSTRUCTIONS

P.O. Box 68323, Bryanston 2021  
14 Susan Str. Strydompark. Randburg  
South Africa  
Tel: (011) 792-1731 Fax (011) 791-0727

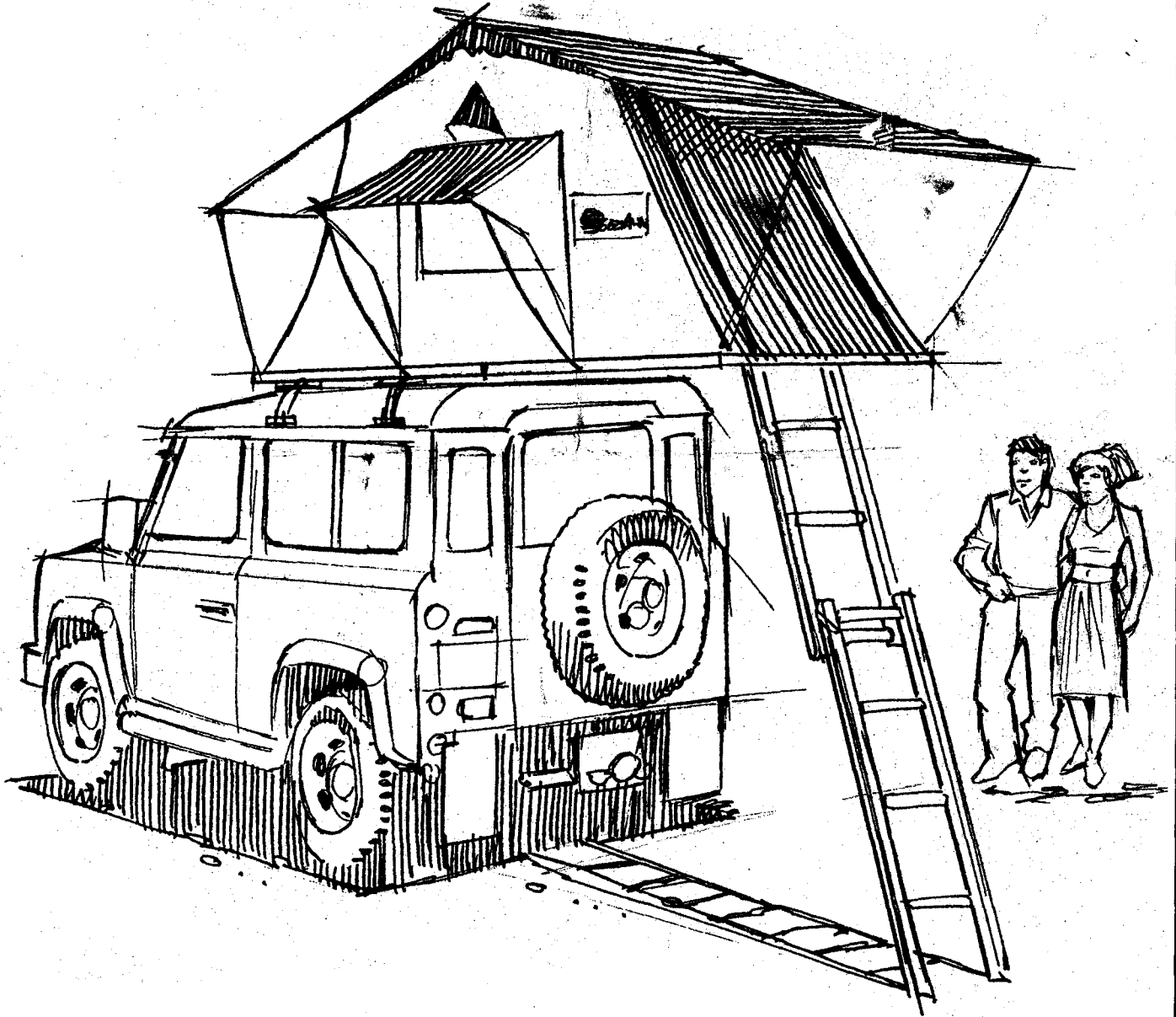

## HELPFUL HINTS

1. Always make sure TENT is dry when stored - away from RATS and MICE.
2. Do not wash TENT with detergent. ONLY wipe with CLEAN CLOTH.

## INSTALLATION INSTRUCTIONS

P.O. Box 68323, Bryanston 2021  
 14 Susan Str. Strydompark. Randburg  
 South Africa  
 Tel: (011) 792-1731 Fax (011) 791-0727

Drop bolt through hole in fixing slide, Insert slide into rail, attached to rooftent base.

Drill hole through roofrack slat or board to accommodate bolt, washer and nyloc-nut supplied.

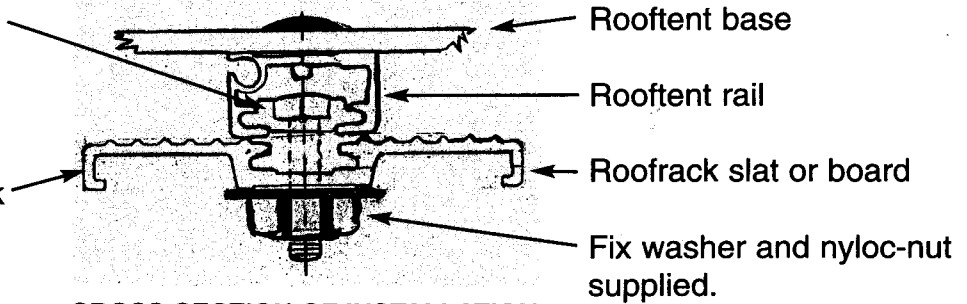

**CROSS-SECTION OF INSTALLATION  
 ROOFTENT TO ROOFRAK**

### PLAN VIEW ROOFTENT BASE RAIL CENTRES

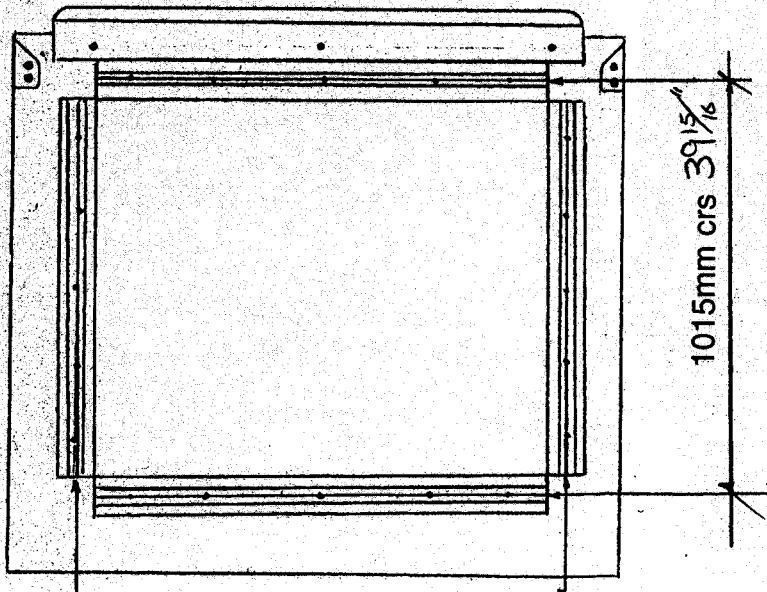

1240mm = 1015mm crs	39 1/16"
1400mm = 1185mm crs	46 5/8"
1600mm = 1385mm crs	54 1/2"

### OPTIONAL EXTRAS TO FIT ROOFTENTS

Gutterless rail system to fit rooftents to vehicles without gutters.

Loadbars to fit rooftents onto vehicles with gutters.

Loadbars to fit rooftent onto roofrack rails.

Bullbar kits for rooftents that are mounted at the front of vehicle roof racks

## OPERATING INSTRUCTIONS TO OPEN

P.O. Box 68323, Bryanston 2021  
14 Susan Str. Strydompark. Randburg  
South Africa  
Tel: (011) 792-1731 Fax (011) 791-0727

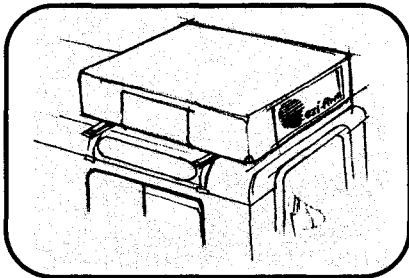

Enclosed rooftop with travel cover.

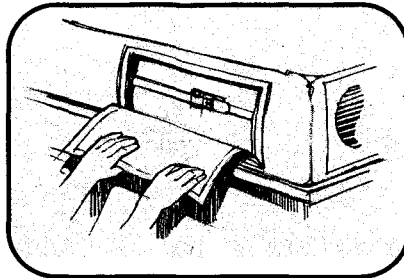

Open flap to access ratchet in order to remove travel cover.

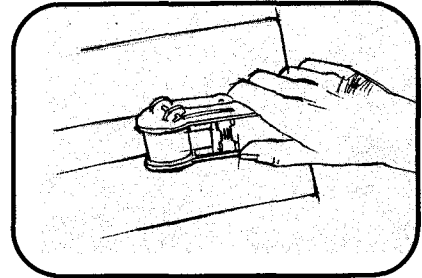

Pull ratchet-head forward to release strap and remove travel cover.

**NOTE:** Should ladder be separately delivered of rooftop, then fit ladder as follows:--

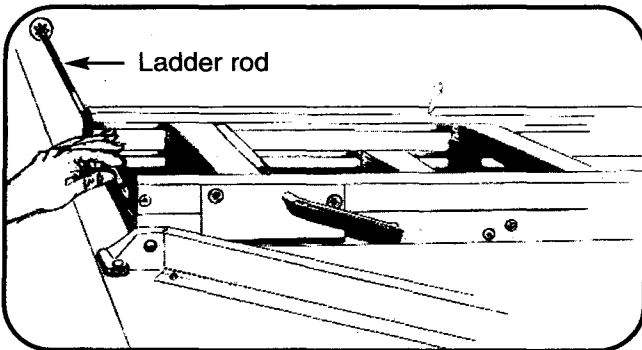

Insert rod through holes of ladder and aluminium castings.

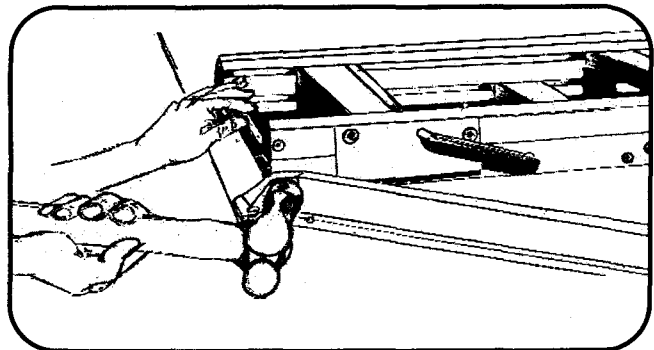

Fix rod by tapping cover-clips to each end.

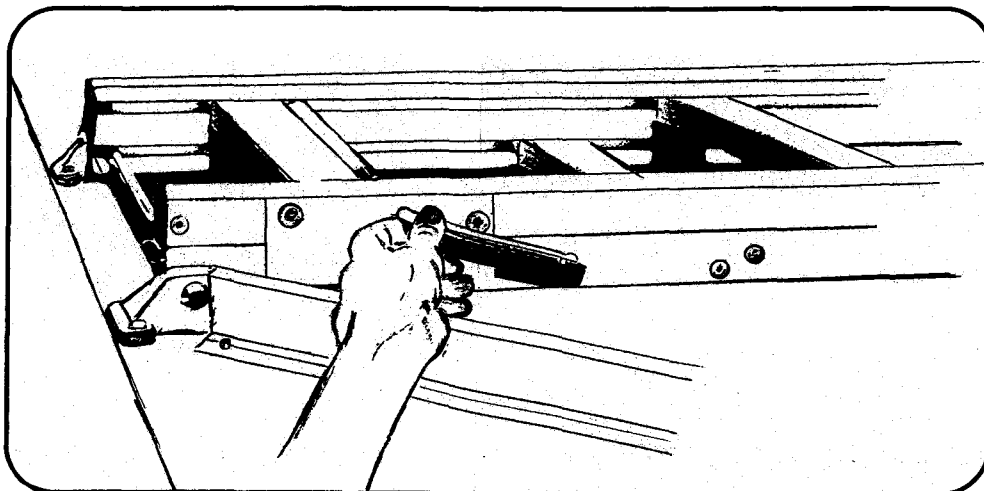

Unlock ladder and slide upper section to full length, relocate in hole provided and lock

## OPERATING INSTRUCTIONS

P.O. Box 68323, Bryanston 2021  
 14 Susan Str. Strydompark. Randburg  
 South Africa  
 Tel: (011) 792-1731 Fax (011) 791-0727

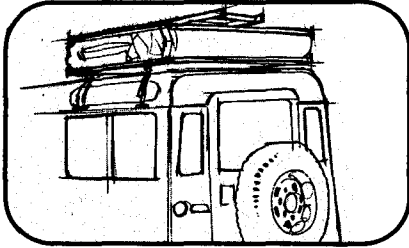

Unlock ladder and slide upper section to full length, relocate in hole provided and lock.

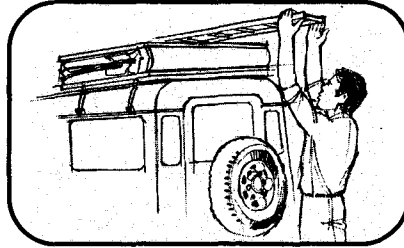

Pull down on fully extended ladder in order to open rooftop tent.

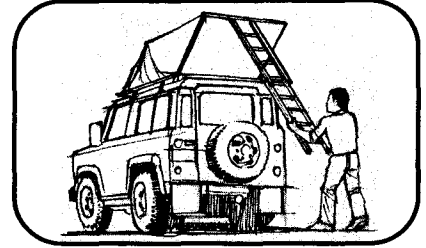

Pull backward to aid unfolding and rest ladder on ground.

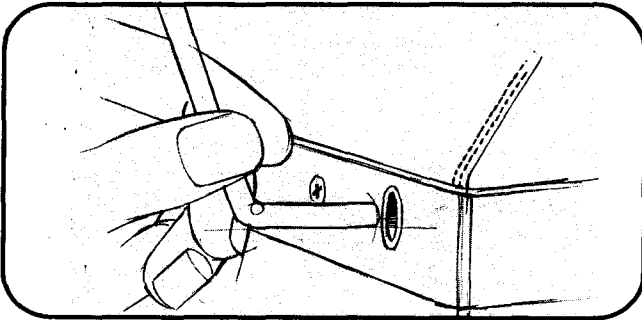

Insert spring steel rods into ferrils of rooftop tent base beading, bend rods and fit into eyelets of rooftop side canopies and flysheets.

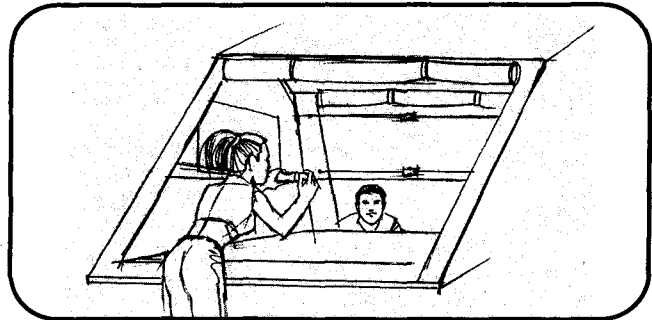

Undo internal plastics clips to release rooftop tent sidewalls.

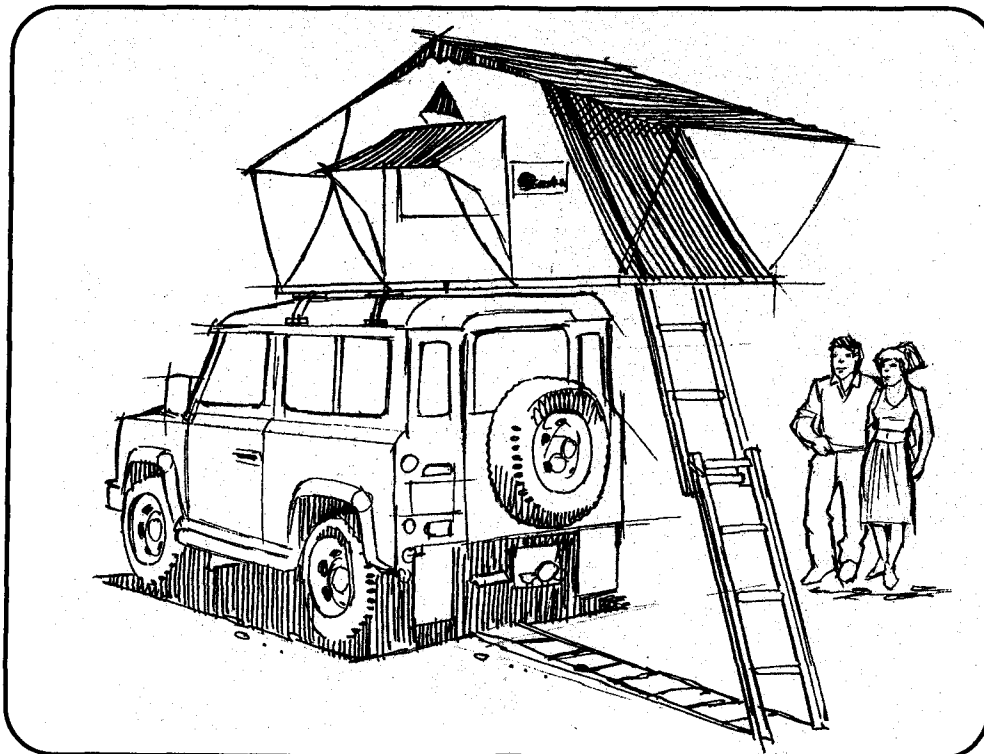

ROOFTENT FULLY SET-UP, READY TO OCCUPY

## OPERATING INSTRUCTIONS TO CLOSE.

P.O. Box 68323, Bryanston 2021  
14 Susan Str. Strydompark. Randburg  
South Africa  
Tel: (011) 792-1731 Fax (011) 791-0727

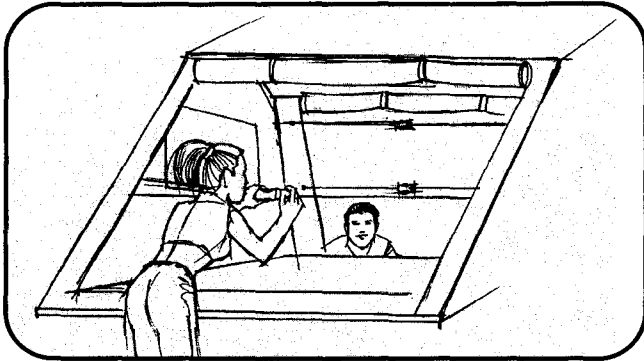

Before closing rooftop, lock plastic clips together to aid folding of rooftop sidewalls .

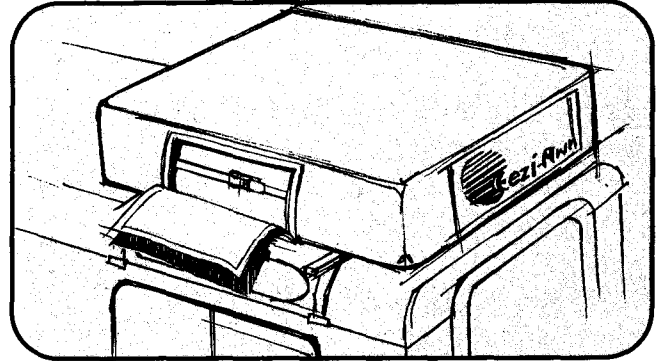

Re-fit travel cover, check that strap is tight across the corners of rooftop base.

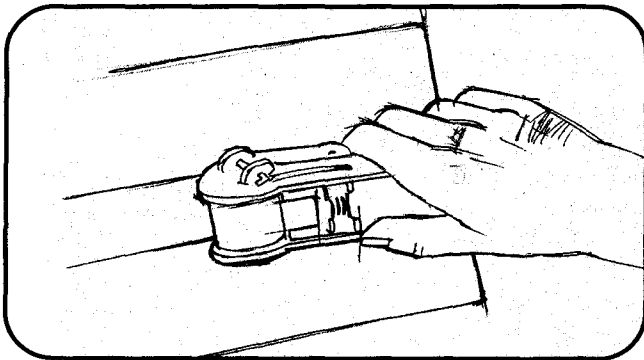

Activate ratchet straps to ensure the travel cover is well secured

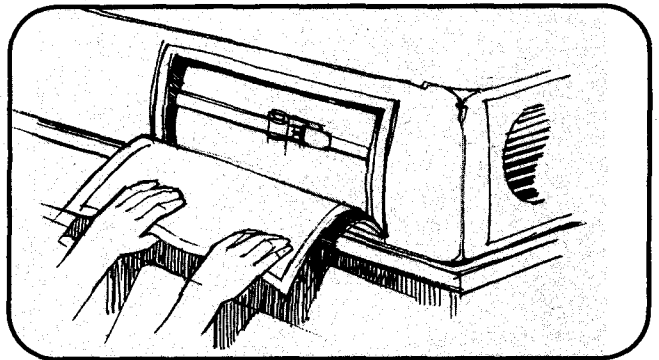

Close ratchet and conceal behind rooftop flap.

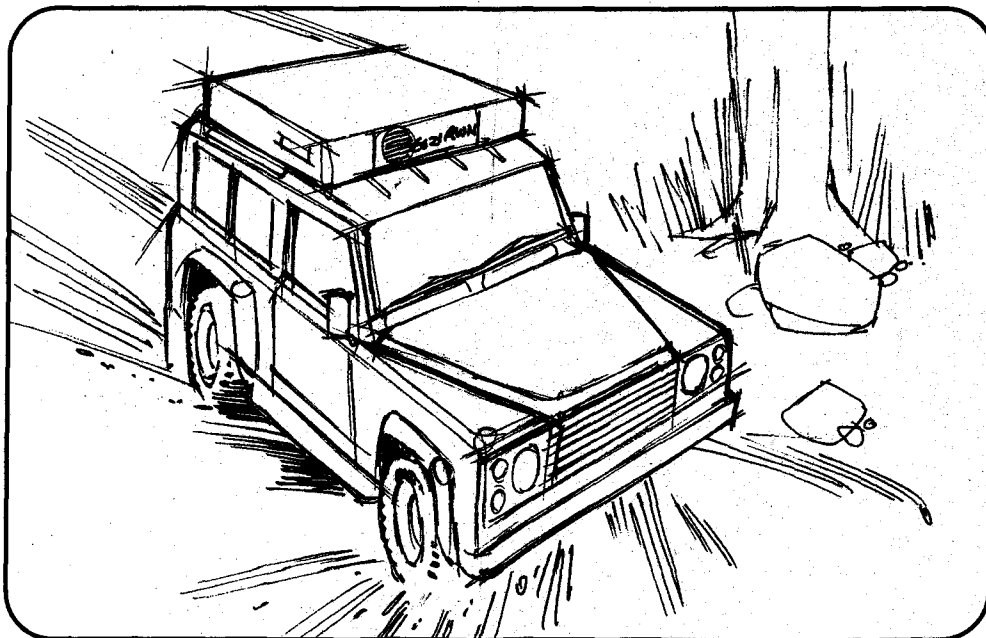

ON THE ROAD AGAIN !! – ENJOY THE RIDE !!

P.O. Box 68323, Bryanston 2021  
14 Susan Str. Strydompark. Randburg  
South Africa  
Tel: (011) 792-1731 Fax (011) 791-0727

## LADDER HEIGHT ADJUSTMENT INSTRUCTIONS

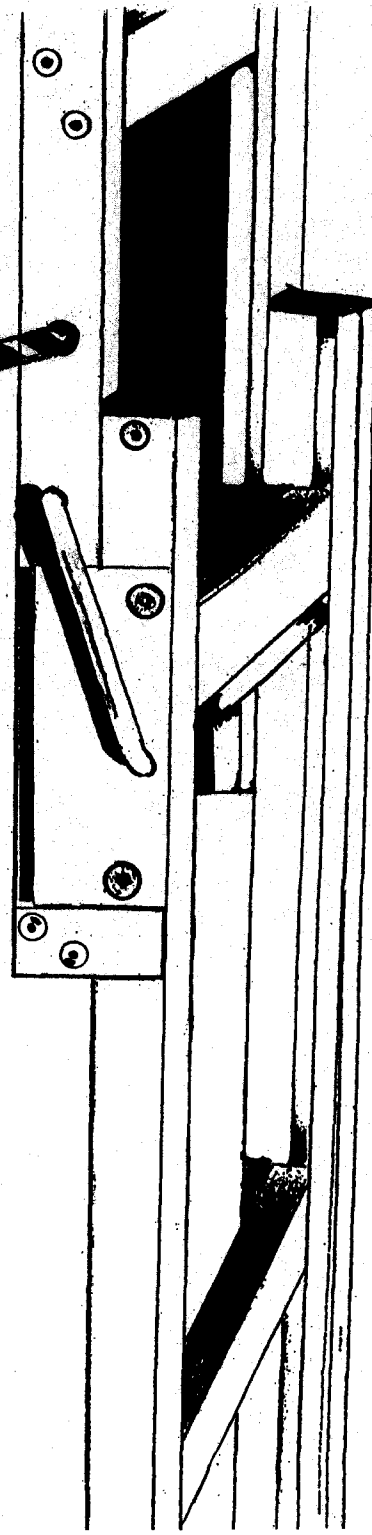
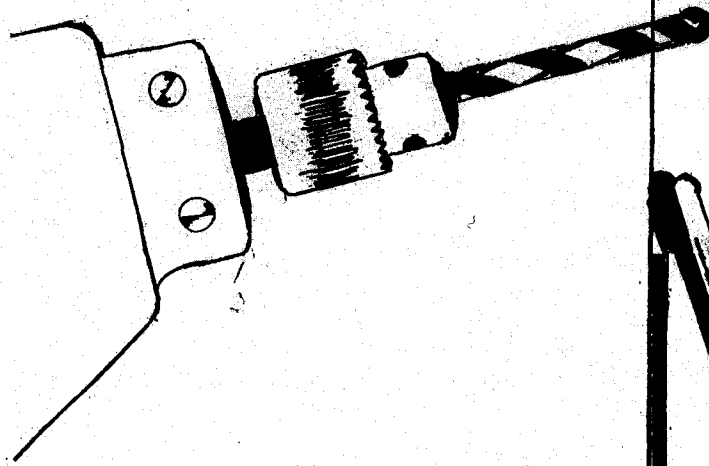

1. Extend the rooftop ladder.
2. Select angle to be comfortable to climb up to rooftop.  
Recommended 5°-10° off the vertical centre
3. Drill 8.5mm hole to locate locking pin both sides of ladder uprights
4. Lock pins into holes, ladder ready to climb up.